



Invoice to:  
 Name:  
 Street:  
 Town: Postal code:  
 E-Mail:  
 Tel: Fax:

Order date:  
 Purchase order:  
 Number required:

Deliver to:  
 Name:  
 Street:  
 Town: Postal code:  
 E-Mail:  
 Tel: Fax:

Marked for:  
 Sunrise order no:

**Transit approved to ISO 7176-19**

(only when transit bracket option is selected in Frame Accessories section on prescription form)

● = Standard    □ = Cost option    ○ = No cost option

Customer service fax number 0845 605 66 89  
 Order online at: [www.sunscript.co.uk](http://www.sunscript.co.uk)

Max. user weight: **120 kg**  
**USER WEIGHT**  kg

Mandatory information to ensure correct configuration

Part. no.: 066001

**Base price £1,995** €3,246

**CLIENT MEASUREMENT**

**Seat width in cm**

Seat depth in cm

	32	34	36	38	40	42	44	46
34	○	○	○	○	○	○	○	○
36	○	○	○	○	○	○	○	○
38	○	○	○	○	○	○	○	○
40	○	○	○	○	○	○	○	○
42	○	○	○	○	○	○	○	○
44	○	○	○	○	○	○	○	○
46	○	○	○	○	○	○	○	○
48	○	○	○	○	○	○	○	○

SD 34-38cm have the frame length of SD 38cm

Your rear seat height can only be between 0cm and 13cm below your front seat height:

i.e. rear seat height CANNOT be above front seat height

i.e. rear seat height CANNOT be more than 13cm below front seat height

- More info, see first back page

# 4" & 5" soft roll and 5" & 6" soft solid are only available with a 45mm fork

Please note the measurement of seat depth is from the back post

- All measurements are in cm and without a cushion

High frame is 4 cm higher than low frame and you can choose shorter and lighter forks to minimize the weight of your wheelchair. See next page

**Front seat height in cm**

Front Castor

	Fork (length x width)	Frame:	42	43	44	45	46	47	48	49	50	51	52	53	54	55	56
3"	98 mm x 32 mm	Low		○	○	○											
	111 mm x 32 mm	Low			○	○	○										
	98 mm x 32 mm	High						○	○	○							
	111 mm x 32 mm	High							○	○	○						
4"	111 mm x 45 mm	Low				○	○	○									
	123 mm x 45 mm	Low				○	○	○									
	98 mm x 32 mm	Low			○	○	○										
	111 mm x 32 mm	Low			○	○	○										
	111 mm x 45 mm	High							○	○	○						
	123 mm x 45 mm	High							○	○	○	○					
5"	98 mm x 32 mm	High							○	○	○						
	111 mm x 32 mm	High							○	○	○						
	111 mm x 45 mm	High										○	○				
	123 mm x 45 mm	High										○	○	○	○		
6"	98 mm x 32 mm	High									○	○					
	111 mm x 32 mm	High									○	○	○				
	123 mm x 45 mm	High												○	○		



Standard design  
98mm, 111mm,  
32mm width



Standard design  
111mm  
123mm, 45mm width

**Please follow measuring method:**

The following method is recommended on the basis of extensive practical experience.

Deviations are possible in individual instances

**Seat width:**

**a) For the user:**

Allow space between side guard and hip on each side of the chair (approx. 1 - 2cm all together).



**b) On the wheelchair:**

From outside frame tube to outside frame tube

**Seat depth:**

**a) For the user:**

When sitting upright: leave space for 2-3 fingers between front edge of seat upholstery and back of knee (approx. 3-6cm). Care must be taken with adjustable upholstery.

**b) On the wheelchair:**

From back tube to front of seat upholstery.

**Back height:**

**a) For the user:**

Measured from the seat, including cushion, to be **no more** than one finger (1 - 2cm) below the lower shoulder blade.

**Important!** The back height depends on the degree of disability.

**b) On the wheelchair:**

From seat tube to upper edge of backrest upholstery.

**Note:** The user's ability to sit upright has a major influence on the back height and it can therefore vary considerably.

**Lower leg length (LLL):**

**a) For the user:**

With legs angled at right angles, from back of knee to bottom of shoe sole.

**Remember: to deduct the cushion height when providing the measurement**

**b) On the wheelchair:**

From front of seat to top of footrest.

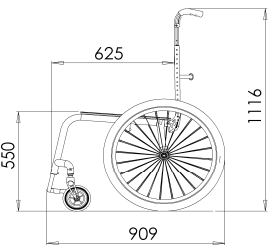
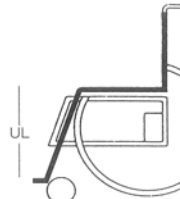
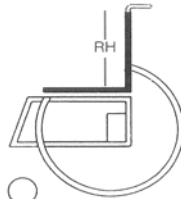
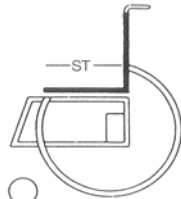
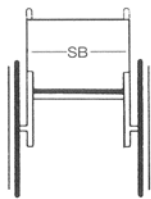

**Overall width:**

Overall width:  
Max overall height 112cm  
Max overall length 91cm

**Overall width with:**

For 0° camber:	24"	SW+20cm
For 3° camber:	25"	SW+26cm
For 6° camber:		SW+32cm

**Weights:**

Minimum weight: each with hand rim distance std from 6.44kg

Please note that the matrix is based on a std configuration

**Std chair 40 x 40 cm, 3° camber, 5.60cm CoG**

**Seat angle of 8°**

All changes in the configuration might change the seat heights.

Manufacturing tolerances of +/- 1 cm

**NOTES:**

Max seat height difference rear to front is 13cm.

No negative seat angle is possible

**Please note that the matrix is based on a standard configuration**

**Low seat frame vs. High seat frame**

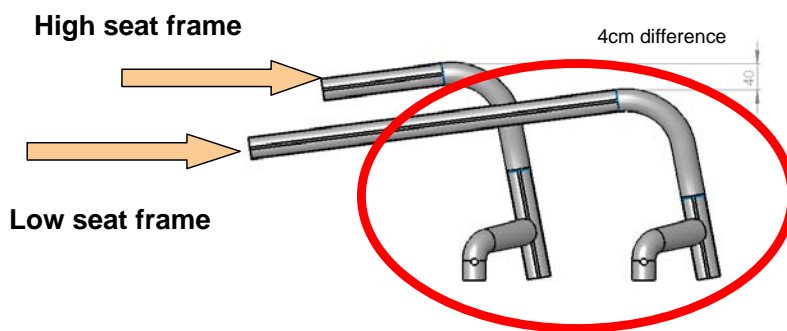

**QUICKIE Helium**

● = Standard    ○ = No cost option    □ = Cost option

Rear wheel	Rear seat height in cm <small>(the ordered rear seat height is adjustable +/- 1 cm on each chair) (1)</small>																						
	Wheels	Axle plate:	34	35	36	37	38	39	40	41	42	43	44	45	46	47	48	49	50	51	52		
	24"						○	○	○	○	○	○	○	○	○	○	○	○	○	○	○	○	○
25"																							

SEAT UPHOLSTERY		
<b>Seat Sling Standard (2)</b>		
3002	○ With 1 Utility bag	
3006	□ With two utility bags <small>(only from SW 34 cm)</small>	38 62
3005	□ With one utility bag plus one catheter bag <small>(only from SW 34 cm)</small>	60 98
3020	□ <b>Seat Sling Clip Style (Airflow) (user weight limit 100kg) (2)</b>	142 231
3014	□ With 1 Utility bag	177 288
3017	□ With two utility bags <small>(only from SW 34 cm)</small>	200 325
3018	□ With one utility bag plus one catheter bag <small>(only from SW 34 cm)</small>	223 363
3001	○ Without seat sling	
<b>JAY Cushions - for complete product range see Jay order forms</b>		
JAY020002	□ JAY Basic	46 75
JAY020003	□ JAY Soft Combi P	64 104
JAY020001	□ JAY Easy Visco, Curved Base	109 177
JAY020007	□ JAY Easy Fluid, Curved Base	251 408
JAY020004	□ JAY Lite	179 291
<b>Seat cushion with cover, black</b>		
3026	a) Foam composite Thickness: □ 3cm □ 5cm <small>(medium)</small>	48 78
3027	b) Latex Thickness: □ 5cm □ 8cm <small>(very soft)</small>	48 78
<b>Seat cushion with water resistant / breathable cover</b>		
3028	a) Foam composite Thickness: □ 3cm □ 5cm <small>(medium)</small>	91 148
3029	b) Latex Thickness: □ 5cm □ 8cm <small>(very soft)</small>	91 148
<b>Seat accessories</b>		
4049	□ Positioning belt with lock	31 50
3003	□ Spare cushion cover with zipper	33 54

For more JAY information please call **0845 605 66 88** or see JAY order forms

BACKREST				
<b>Backrest (JAY compatible)</b>				
	<b>25 - 30cm</b>	<b>30 - 40cm</b>	<b>40 - 45cm</b>	<small>(height adjustable)</small>
○ Standard adjustable backrest	○ 25	○ 30	○ 40	
<b>Back height factory set at (cm)</b>	○ 27.5	○ 32.5    ○ 37.5	○ 42.5	
	○ 30	○ 35    ○ 40	○ 45	

□ **Oval shaped backrest (OSB) (NB transit backrests cannot be fitted with OSB) (oval and narrow towel bar, non height adjustable)**

4067	○ 25    □ 27.5    □ 30    □ 32.5    □ 35    □ 37.5    □ 40    □ 42.5    □ 45	172	280
4029	○ Foldable, angle adjustable standard, single locking <small>(-31° to +15°) (only in black anodizing)</small>		
4018	○ Angle adjustable fixed (non foldable) <small>(-31° to +15°)</small>		
4016	□ Double locking function (locks also in the folded position) <small>(-31° to +15°)</small>	40	65
4068	□ Backrest ONE size smaller than standard (SW - 2 cm)	114	185



Push handles			
4054	○ Without push handles		
4042	○ Short		
4022	○ Long		
4024	□ Fold-down push handles <small>(only available from 32.5 cm standard back)</small>	95	155
4034	□ Height-adjustable push handles <small>(Not possible with OSB (4067) &amp; from 32.5cm on std back only)</small>	127	207
4043	□ JAY 3 Hardware height-adjustable push handles <b>NEW OPTION</b>	127	207



Backrest upholstery			
4032	○ Adjustable backrest upholstery (nylon) <b>(3) IMPROVED DESIGN</b>		
4069	□ Air flow (lightweight) adj backrest upholstery <b>IMPROVED DESIGN</b>	165	268
4038	□ Adjustable backrest with vented material □ Black □ Silver <b>(3)</b>	110	179
4070	□ Comfort upholstery <b>(3)</b> □ Grey □ Brown <small>(adjustable backrest with Alcantara material)</small>	274	446
4031	□ Without back upholstery		

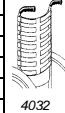

JAY Backs plus Accessories - for complete product range see Jay order forms			
<b>Jay 3 Back - Shallow Contour</b>			
Mid Thoracic:		□ JAY030010 Medium - 34 cm	□ JAY030033 Tall - 38 cm
Upper Thoracic:	□ JAY030012 Short - 42 cm	□ JAY030019 Medium - 46 cm	□ JAY030025 Tall - 50 cm
Shoulder Height:	□ JAY030015 Short - 53 cm	□ JAY030022 Medium - 57 cm	□ JAY030028 Tall - 61 cm
<b>Jay 3 Back - Mid Contour</b>			
Mid Thoracic:		□ JAY030011 Medium - 34 cm	□ JAY030018 Tall - 38 cm
Upper Thoracic:	□ JAY030013 Short - 42 cm	□ JAY030020 Medium - 46 cm	□ JAY030026 Tall - 50 cm
Shoulder Height:	□ JAY030016 Short - 53 cm	□ JAY030023 Medium - 57 cm	□ JAY030029 Tall - 61 cm
<b>Jay 3 Back - Deep Contour</b>			
Upper Thoracic:	□ JAY030014 Short - 42 cm	□ JAY030021 Medium - 46 cm	□ JAY030027 Tall - 50 cm
Shoulder Height:	□ JAY030017 Short - 53 cm	□ JAY030024 Medium - 57 cm	□ JAY030030 Tall - 61 cm
<b>Jay 3 Back - Posterior Deep Contour</b>			
Upper Thoracic:		□ JAY030031 Medium - 46 cm	
Shoulder Height:	□ JAY030032 Short - 53 cm		

SIDE GUARDS/ARMREST		
4247	□ Slim style carbon fibre side guard <b>(4)</b> <small>(slim style, carbon fibre)</small>	225 366
4229	□ Straight side guard aluminium <b>IMPROVED DESIGN</b>	167 272
4238	□ Fender side guard aluminium <b>IMPROVED DESIGN</b> <small>(min seat height 39 cm)</small>	180 293
4232	□ Fender side guard carbon fibre <b>IMPROVED DESIGN</b> <small>(min seat height 39 cm)</small>	236 384
4263	□ Plastic side guard detachable <b>(5) NEW OPTION</b> <small>(Quickie style)</small>	122 198
4264	□ Single post height adjustable armrest <b>(6 &amp; 7) NEW OPTION</b> <small>(Quickie style)</small>	131 213



LEGREST & FOOTPLATES		
<b>Footplates</b>		
2106	○ Lightweight tubular footrest <small>(lower leg length between 36 cm - 52.5 cm)</small>	
2105	□ Lightweight tubular footrest with flat cover <small>(lower leg length between 36 cm - 52.5 cm)</small>	55 89
2101	Platform footrest angle and depth adjustable <small>(lower leg length between 36 cm - 52.5 cm)</small>	□ Aluminium footplate in frame colour
		□ Composite Footplate
2097	□ Performance platform footrest angle adjustable <small>(lower leg length between 36 cm - 52.5 cm)</small>	165 268
2102	□ High mounted platform footplates, aluminium <small>(high mounted for lower leg length between 22 - 39 cm)</small>	110 179
2133	□ Foot positioning plate <small>(only in combination with 2101 &amp; 2102)</small>	49 80

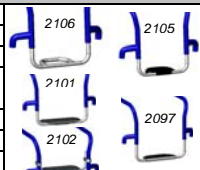

- (1): note with 37 cm and 49 cm with 24" rear wheel/no additional decline or increase of the seat possible note with 38 cm and 50 cm with 25" rear wheel/no additional decline or increase of seat height possible
- (2): No change from std to clipstyle seat sling possible (and visa versa) possible in the field
- (3): reduces the seat depths of approx 1cm due to padding
- (4): with 24" rear wheel minimum rear seat height 41cm, with 25" rear wheel minimum rear seat height 43cm
- (5): Not with COG 9. 2 & 10.4cm in combination with lightweight upholstery
- (6): Not in combination with COG 8, 9,2 & 10.4cm in combination with lightweight seat upholstery
- (7): Not in combination with compact lightweight wheel lock



For more information visit our webpage [www.sunrisemedical.com](http://www.sunrisemedical.com)

### Frame inset table

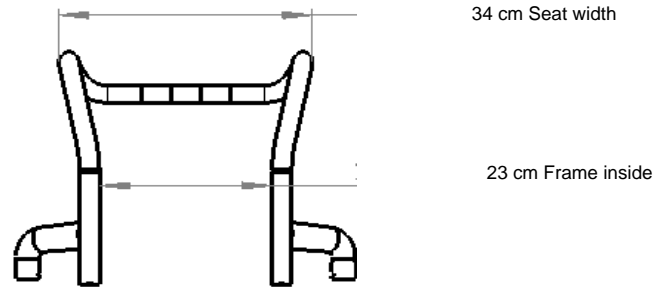
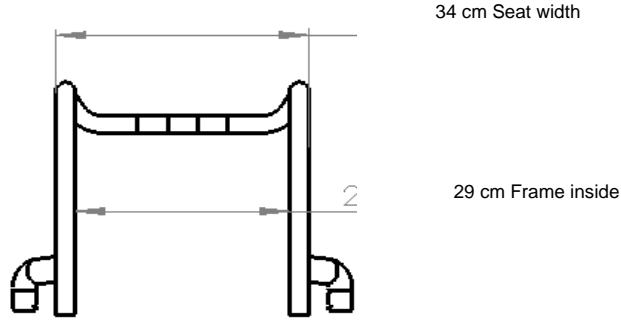
Seat width		32	34	36	38	40	42	44	46
Inset									
0 cm		27	29	31	33	35	37	39	41
3cm each side		XXX	23	25	27	29	31	33	35

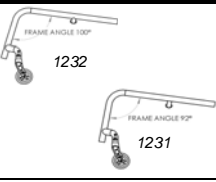
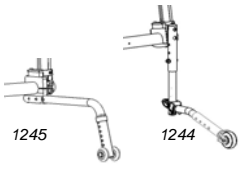

Lower Leg Length on the HIGH FRAME						Lower Leg Length on the LOW FRAME					
LOWER LEG LENGTH	TUBULAR FOOTREST w/o cover	PERFORMANCE FOOTREST	ALUMINIUM FOOTREST	PLASTIC FOOTREST	HIGH MOUNTED FOOTREST	LOWER LEG LENGTH	TUBULAR FOOTREST w/o cover	PERFORMANCE FOOTREST	ALUMINIUM FOOTREST	PLASTIC FOOTREST	HIGH MOUNTED FOOTREST
22	NO GO	NO GO	NO GO	NO GO	X	22	NO GO	NO GO	NO GO	NO GO	X
23	NO GO	NO GO	NO GO	NO GO	X	23	NO GO	NO GO	NO GO	NO GO	X
24	NO GO	NO GO	NO GO	NO GO	X	24	NO GO	NO GO	NO GO	NO GO	X
25	NO GO	NO GO	NO GO	NO GO	X	25	NO GO	NO GO	NO GO	NO GO	X
26	NO GO	NO GO	NO GO	NO GO	X	26	NO GO	NO GO	NO GO	NO GO	X
27	NO GO	NO GO	NO GO	NO GO	X	27	NO GO	NO GO	NO GO	NO GO	X
28	NO GO	NO GO	NO GO	NO GO	X	28	NO GO	NO GO	NO GO	NO GO	X
29	NO GO	NO GO	NO GO	NO GO	X	29	NO GO	NO GO	NO GO	NO GO	X
30	NO GO	NO GO	NO GO	NO GO	X	30	NO GO	NO GO	NO GO	NO GO	X
31	NO GO	NO GO	NO GO	NO GO	X	31	NO GO	NO GO	NO GO	NO GO	X
32	NO GO	NO GO	NO GO	NO GO	X	32	NO GO	NO GO	NO GO	NO GO	X
33	NO GO	NO GO	NO GO	NO GO	X	33	NO GO	NO GO	NO GO	NO GO	X
34	NO GO	NO GO	NO GO	NO GO	X	34	NO GO	NO GO	NO GO	NO GO	X
35	NO GO	NO GO	NO GO	NO GO	X	35	NO GO	NO GO	NO GO	NO GO	X
36	X	X	X	X	NO GO	36	NO GO	NO GO	NO GO	NO GO	X
37	X	X	X	X	NO GO	37	NO GO	NO GO	NO GO	NO GO	X
38	X	X	X	X	NO GO	38	NO GO	NO GO	NO GO	NO GO	X
39	X	X	X	X	NO GO	39	NO GO	NO GO	NO GO	NO GO	X
40	X	X	X	X	NO GO	40	X	X	X	X	NO GO
41	X	X	X	X	NO GO	41	X	X	X	X	NO GO
42	X	X	X	X	NO GO	42	X	X	X	X	NO GO
43	X	X	X	X	NO GO	43	X	X	X	X	NO GO
44	X	X	X	X	NO GO	44	X	X	X	X	NO GO
45	X	X	X	X	NO GO	45	X	X	X	X	NO GO
46	X	X	X	X	NO GO	46	X	X	X	X	NO GO
47	X	X	X	X	NO GO	47	X	X	X	X	NO GO
48	X	X	X	X	NO GO	48	X	X	X	X	NO GO
49	X	X	X	X	NO GO	49	X	X	X	X	NO GO
50	X	X	X	X	NO GO	50	X	X	X	X	NO GO
51	X	X	X	X	NO GO	51	X	X	X	X	NO GO
52	X	X	X	X	NO GO	52	X	X	X	X	NO GO

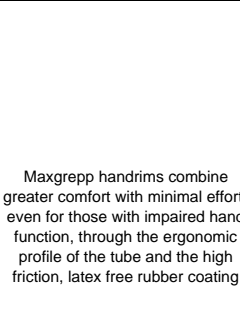
QUICKIE Helium		£	€
● = Standard    ○ = No cost option    □ = Cost option			
<b>Lower leg length (LLL)</b> (Attention: LLL has to be 2.5 cm less than seat height front) (please refer to back page 1)			
○ 22    ○ 23    ○ 24    ○ 25    ○ 26    ○ 27    ○ 28    ○ 29 ○ 30    ○ 31    ○ 32    ○ 33    ○ 34    ○ 35    ○ 36    ○ 37 ○ 38    ○ 39    ○ 40    ○ 41    ○ 42    ○ 43    ○ 44    ○ 45 ○ 46    ○ 47    ○ 48    ○ 50    ○ 51    ○ 52		(seat to footplate)	
		<b>All measurements are in cm</b>	
<b>FRAME</b>			
1232	○ Std frame knee angle 100° (80° for UK) (1)		
1231	□ Helium performance knee angle 92° (88° for UK) (2)	85	138
1280	Frame inset (each side of the frame) (please refer to the frame inset table) ○ Std inset (0cm)		
1282	□ Helium performance inset (3cm) (not available for seat width 32 cm)	85	138
			
<b>CENTRE OF GRAVITY (COG) &amp; AXLE PLUG</b> (all measurements are in cm) (choose only one option)			
Choose only one of the 8 choices (measured from front of back post in cm)		<b>When choosing COG less than 5.6 axle adaptor is used</b>	
○ 2.00cm    ○ 4.40cm    ○ 6.80cm    ○ 9.20cm			
○ 3.20cm    ○ 5.60cm    ○ 8.00cm    ○ 10.40cm			
<b>FRAME ACCESSORIES</b>			
8999	□ Crash test /transport brackets (not with oval shaped backrest)	52	85
5184	□ <b>Suspension (3)</b> □ user weight - 70kgs HLM0800    □ user weight - 120kgs HLM080019	335	545
<b>Tip assist (step tube)</b> (choose either tip assist or anti- tip tubes, not both)			
1230	□ Left    1230    □ Right	22	36
1205	□ Crutch holder with Velcro (only in combination with 1230)	49	80
<b>Anti-tip tubes, swing-away</b>			
1244	□ Left    1244    □ Right	65	106
1244	□ Pair	130	212
1245	□ Quickie style anti-tip tubes pluggable (pair)	55	89
1247	□ Transit wheel	144	234
1281	□ Frame protection	49	80
			
<b>STANDARD CASTOR</b> (compare with your choice on the first page)			
5812	○ Solid		
5823	○ Soft solid (for 45 mm fork version only) (only for 5" & 6")		
<b>Light ups</b>			
5850	□ Solid (not available for 6")	49	80
<b>Castor with aluminium rim</b>			
5852	□ Solid (only for 4" and 5")	58	94
5855	□ Soft roll castor with aluminium rim wide version (for 45 mm fork version only) (only for 4" and 5")	58	94
<b>REAR WHEELS</b> (compare with your choice on the first page; choose only one wheel type)			
NOTE: for users with higher user weight than 100 kg, we recommend cross spoked wheels			
5172	○ Cross spoked (pair) (only 24")		
5137	○ Design wheel (pair) (only 24")		
5140	○ 24" Light weight wheel (4) (pair)		
5140	□ 25" Light weight wheel (4) (pair)	157	255
5181	□ Proton wheel (super-lightweight) (4) (pair) (user weight limit 100kg)	357	581
5159	□ Spinergy wheels (5) (pair)	324	527
5162	□ Mountain bike wheel (only with 24", mountain bike tyres & aluminium rim, black coated)	230	374
5162	□ Additional mountain bike wheel pair (only with 24" & mountain bike tyres)	346	563
□ Omit rear wheels		-100	-163
<b>TYRES</b> (choose only one tyre type)			
5125	○ Right Run (only 24")		
5167	□ 2" grip (only 24")	66	107
5118	□ Speedrun (- this is the lightest tyre option, NA Spinergy wheels)	66	107
5168	○ Solid tyres (only 24"; NA Lightweight or Spinergy wheels)		
5164	□ Marathon plus evolution (puncture resistant, adds approximately 800g per chair)	66	107
			
<b>HANDRIM</b> (Not required for Spinergy or Mountain bike wheel)			
5144	○ Aluminium silver powder coated		
5142	○ Aluminium silver anodised		
5183	□ Coloured aluminium pushrim. Specify colour code: .....	46	75
5174	○ Stainless steel (6) (only 24" wheels)		
5122	□ Titanium (only 24" wheels)	137	223
5121	□ Titanium clear powdercoated (only 24" wheels)	137	223
5120	□ Supergrip (6) (only 24" wheels)	165	268
□ Maxgrepp <b>NEW OPTION</b> (only 24" wheels)		165	268
Handrim mounting ○ Standard = 17mm    ○ Wide = 27mm			
○ Close = 7mm (only with stainless steel)			
5178	□ Handrim cover (only 24")	66	107
			
(1): all castor sizes can be used and changed afterwards in the field (2): no change from 3" or 4" castors to 5" or 6" castors in the field (4): not in combination with solid tyres (5168) (5): not available with spoke guards (6): not available with light weight or Porton wheels		For more information visit our webpage <a href="http://www.sunrisemedical.com">www.sunrisemedical.com</a>	

NoGo Matrix Lightweight brake  
 Seat height values are valid with 56 mm COG, seat depth 400 mm and 8° seat angle,  
 axle stem assembled with one spacer

SD 42 - 48											SD 42 - 48																
24"	Front Seat Height										25"	Front Seat Height															
Cog	43	44	45	46	47	48	49	50	51	52	53	54	55	Cog/ S	43	44	45	46	47	48	49	50	51	52	53	54	55
2														2													
3.2														3.2													
4.4														4.4													
5.6														5.6													
6.8														6.8													
8														8													
9.2														9.2													
10.4														10.4													

SD 40											SD 40																
24"	Front Seat Height										25"	Front Seat Height															
Cog/ S	43	44	45	46	47	48	49	50	51	52	53	54	55	Cog/ S	43	44	45	46	47	48	49	50	51	52	53	54	55
2														2													
3.2														3.2													
4.4														4.4													
5.6														5.6													
6.8														6.8													
8														8													
9.2														9.2													
10.4														10.4													

SD 34 - 38											SD 34 - 38																
24"	Front Seat Height										25"	Front Seat Height															
Cog/ S	43	44	45	46	47	48	49	50	51	52	53	54	55	Cog/ S	43	44	45	46	47	48	49	50	51	52	53	54	55
2														2													
3.2														3.2													
4.4														4.4													
5.6														5.6													
6.8														6.8													
8														8													
9.2														9.2													
10.4														10.4													

 Possible

 NoGo

# QUICKIE Helium

● = Standard    ○ = No cost option    □ = Cost option

£    €

## WHEEL CAMBER (choose only one option)

5161 ○ 0°    5161 ○ 3°    5161 ○ 6°

## Spoke guard Please refer to brochure and provide number/description (only available in 24")

Spoke guards    Number     Description

90    146

Please consult the following page of this order form to choose your selection, or to order a copy of our new brochure please call 0845 605 66 88 or e-mail [literaturerequests@sunmed.co.uk](mailto:literaturerequests@sunmed.co.uk). You can also view the brochure online by visiting [www.SunriseMedical.com](http://www.SunriseMedical.com) and navigating to Quickie Helium. You will find the brochure under "Multimedia & Downloads"

## WHEEL LOCKS (choose only one option)

6009	<input type="radio"/>	Standard wheel lock			
6008	<input type="checkbox"/>	Knee lever wheel lock		44	72
6003	<input type="checkbox"/>	Compact wheel lock		44	72
6011	<input type="checkbox"/>	Compact lightweight wheel lock <b>(1) (2)</b>	<i>(pls see matrix on back 3)</i>	114	185
6016	<input type="checkbox"/>	Extension for knee lever wheel lock, slip-on, swing-away <i>(only on 6008)</i>		30	49

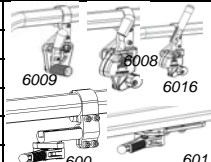

## ACCESSORIES

●	Tool kit				
1402	<input type="checkbox"/>	High pressure pump		55	89
1403	<input type="checkbox"/>	Air pump		11	18
4006	<input type="checkbox"/>	Back pack		44	72
1405	<input type="checkbox"/>	Net back bag		16	26
2118	<input type="checkbox"/>	Bag caddy <b>(3)</b>	<i>(not with platform footplates 2102)</i>	44	72
2113	<input type="checkbox"/>	Mobile phone pouch		33	54



2118

## COLOURS Please consult our colour catalogue to choose your colour selections. To order please call 0845 605 66 88 or e-mail [literaturerequests@sunmed.co.uk](mailto:literaturerequests@sunmed.co.uk)

	Frame	Handrim			Hub/rim		Frame	Handrim			Hub/rim	
		£46	£75	£127	£207	£46		£75	£127	£207		
01	White RAL 9010	<input type="radio"/>	<input type="checkbox"/>	<input type="checkbox"/>	<input type="checkbox"/>							
32	Signal White(crystal white)	<input type="radio"/>	<input type="checkbox"/>	<input type="checkbox"/>	<input type="checkbox"/>							
02	Brilliant Silver	<input type="radio"/>	<input type="checkbox"/>	<input type="checkbox"/>	<input type="checkbox"/>							
04	Silver	<input type="radio"/>	<input type="checkbox"/>	<input type="checkbox"/>	<input type="checkbox"/>							
06	Sun Yellow	<input type="radio"/>	<input type="checkbox"/>	<input type="checkbox"/>	<input type="checkbox"/>							
07	Brilliant Lime	<input type="radio"/>	<input type="checkbox"/>	<input type="checkbox"/>	<input type="checkbox"/>							
08	Matt Lime	<input type="checkbox"/> £69	£112	<input type="checkbox"/>	<input type="checkbox"/>							
09	Candy Teal	<input type="checkbox"/>	<input type="checkbox"/>	<input type="checkbox"/>	<input type="checkbox"/>							
10	Matt Candy Teal	<input type="checkbox"/> £69	£112	<input type="checkbox"/>	<input type="checkbox"/>							
14	Blue	<input type="radio"/>	<input type="checkbox"/>	<input type="checkbox"/>	<input type="checkbox"/>							
15	Brilliant Marine	<input type="radio"/>	<input type="checkbox"/>	<input type="checkbox"/>	<input type="checkbox"/>							
16	Matt Marine	<input type="checkbox"/> £69	£112	<input type="checkbox"/>	<input type="checkbox"/>							
19	Brilliant Purple	<input type="radio"/>	<input type="checkbox"/>	<input type="checkbox"/>	<input type="checkbox"/>							
20	Matt Purple	<input type="checkbox"/> £69	£112	<input type="checkbox"/>	<input type="checkbox"/>							
21	Red Ruby	<input type="radio"/>	<input type="checkbox"/>	<input type="checkbox"/>	<input type="checkbox"/>							
22	Brilliant Red	<input type="radio"/>	<input type="checkbox"/>	<input type="checkbox"/>	<input type="checkbox"/>							
23	Matt Red	<input type="checkbox"/> £69	£112	<input type="checkbox"/>	<input type="checkbox"/>							
24	Tutti Fruitti Orange	<input type="radio"/>	<input type="checkbox"/>	<input type="checkbox"/>	<input type="checkbox"/>							
26	Silver Texture	<input type="radio"/>	<input type="checkbox"/>	<input type="checkbox"/>	<input type="checkbox"/>							
27	Graphite Metallic	<input type="radio"/>	<input type="checkbox"/>	<input type="checkbox"/>	<input type="checkbox"/>							
28	Platinum Metallic	<input type="radio"/>	<input type="checkbox"/>	<input type="checkbox"/>	<input type="checkbox"/>							
29	Black	<input type="radio"/>	<input type="checkbox"/>	<input type="checkbox"/>	<input type="checkbox"/>							
31	Matt Black	<input type="checkbox"/> £69	£112	<input type="checkbox"/>	<input type="checkbox"/>							

### Anodised colour package for fork and back bracket

03	Silver Matt	<input type="checkbox"/> (4)	£69	£112
24	Tutti Fruitti Orange	<input type="checkbox"/> (4)		
29	Black	<input type="radio"/>		

(1) not available with 6° camber - Please check nogo matrix  
 (2) COG adjustment in the field of 4cm only  
 (3) not in combination with performance footrest or high mounted footrest  
 (4) not available with the std back angle adjustment, single locking

**Comments for special build:**



<b>Helium - Base Price</b>	£1,995	€3,246
Option price		
Exclusive VAT		
VAT.		
<b>Total Price</b>		

Sunrise Medical Customer Services Thorns Road, Brierley Hill, West Midlands DY5 2LD Tel. 0845 605 66 88 Fax. 0845 605 66 89	E-mail: <a href="mailto:orders@sunmed.co.uk">orders@sunmed.co.uk</a> Order online at: <a href="http://www.sunscript.co.uk">www.sunscript.co.uk</a>	For more information visit our website <a href="http://www.sunrisemedical.com">www.sunrisemedical.com</a>
--	---	---



5000 - Princess Life



5001 - Dancing Bear



5002 - Jungle Fever



5004 - Happy Lions



5005 - Water World



5006 - Randolph



5007 - Monkeys



5008 - Pirates



5015 - Feather



5025 - Oriental



5012 - Racing



5014 - Dirt Race



5003 - Superhero



5018 - Graffiti



5017 - Chrome Wheel



5016 - Hot Wheels



5023 - Basketball



5024 - Basketball 2



5013 - Pool



5022 - Flying Water



5021 - Space



5020 - Silk



5011 - Abstract



5019 - Creative



5009 - Tiger



5010 - Zebra



5135 - Cheese



5129 - Bibbo



5134 - Galactica



5127 - Rotation



5130 - Fantasy



5128 - Graphic